

## SPECIFICATION FOR COB LED

**Part No:**LC35-050W-W

**Description:**

35\*35mm COB LED 5W Warm white

**Dice Material:** InGaN

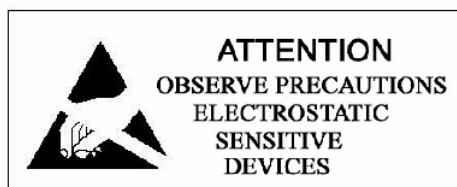

## LC35-050W-W

### W-Series COB LED



### Introduction

Lume COB W series LED Light engine is based on our main patent----- **MCOB** ( **M**ulti-**C**hips **O**n **B**oard ) . Lume COB LEDs combine tens or hundreds power LED chips with a rugged package capable of operating in excess of power . Lume COB LEDs maximumly decrease LED uncomfortable glare and also Zebra strips, at the same time increase LED light efficiency and reduce thermal resistance.

### Features:

- ◇ Area light source, which can avoid glare
- ◇ More energy efficient than incandescent , halogen and some fluorescent lamps
- ◇ Industry's lowest thermal resistance
- ◇ Long operating life, lumen maintenance of greater than 70% after 50,000 hours
- ◇ Low forward voltage operated
- ◇ Instant light (less than 100ns)
- ◇ Lead Free product, RoHS compliant
- ◇ No UV

### Ceramic Board:

- ▶ thermal resistance 1-3 °C/W
- ▶ conductivity 18W/m.K compared to aluminium COB 0.8-1W/m.K
- ▶ insulating
- ▶ pass hi-pot test

## Application

- ◇ Automotive interior / exterior lighting
- ◇ Automotive signal lighting
- ◇ General Torch
- ◇ Architectural lighting
- ◇ LCD TV / Monitor Backlight
- ◇ Projector light source
- ◇ Traffic signals
- ◇ Task lighting
- ◇ Decorative / Pathway lighting
- ◇ Remote / Solar powered lighting
- ◇ Household appliances

## Outline Dimensions:

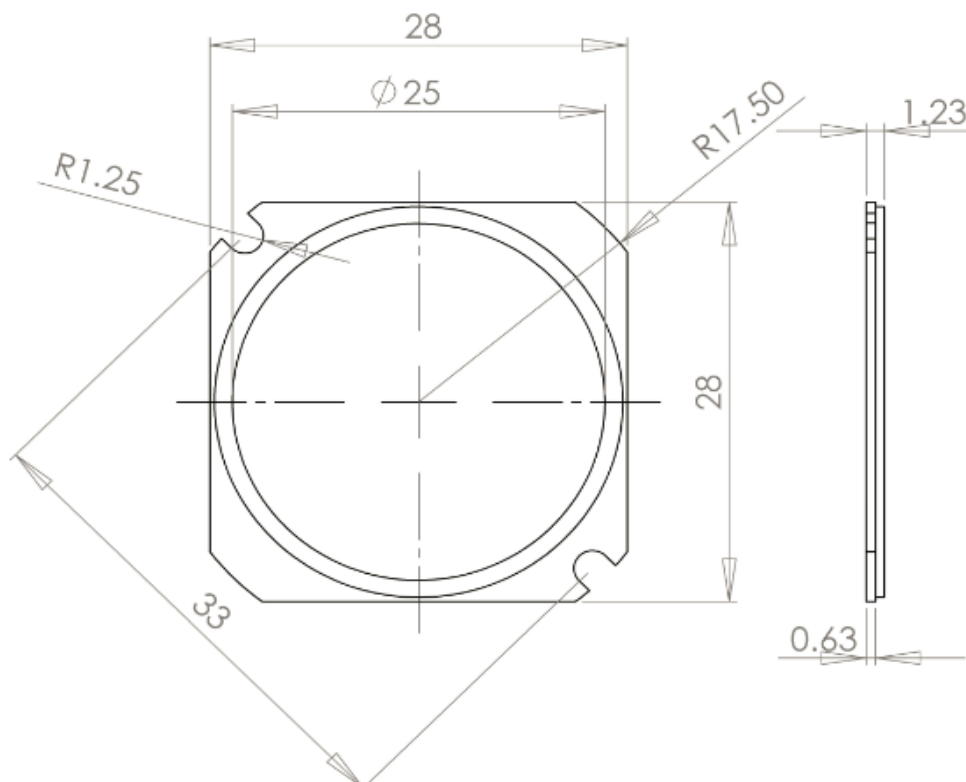

**LC35-050W-W**

## Absolute Maximum Ratings at $T_a=25^{\circ}\text{C}$ :

Parameter	Part No.	Symbol	Maximum	Unit
Power Dissipation	LC35-050W-W	Pd	5	W
Peak Forward Current (1/10 Duty Cycle, 0.1ms Pulse Width)		IF(peak)	300	mA
Continuous Forward Current		IF	200	mA
LED junction temperature		JT	150	°C
Reverse Voltage		VR	40	V
Thermal Resistance, junction to case	LC35-050W-W	R $\theta$ j-c	2.0	°C/W
Soldering Temperature °C	3.5 seconds, 260°C or lower			
Operating temperature range		Topr	-20°C to + 60°C	
Storage Temperature Range		Tstg	-40°C to + 100°C	

## ● Warm white

Parameter	Part No.	Symbol	Test Condition	Min.	Typ.	Max.	Unit
Luminous flux	LC35-050W-W	$\phi$	I <sub>F</sub> =200mA	520	/	550	lm
Viewing Angle		2 $\theta$ 1/2			120		deg
Forward Voltage		V <sub>F</sub>	I <sub>F</sub> =200mA	24.5	/	25.5	V
Reverse Current		I <sub>R</sub>	V <sub>R</sub> =40V			100	uA
Correspondingly		CCT		3000	/	3300	K
Color Rendering Index		CRI		65	/	70	

## Relative Spectral Power Distribution

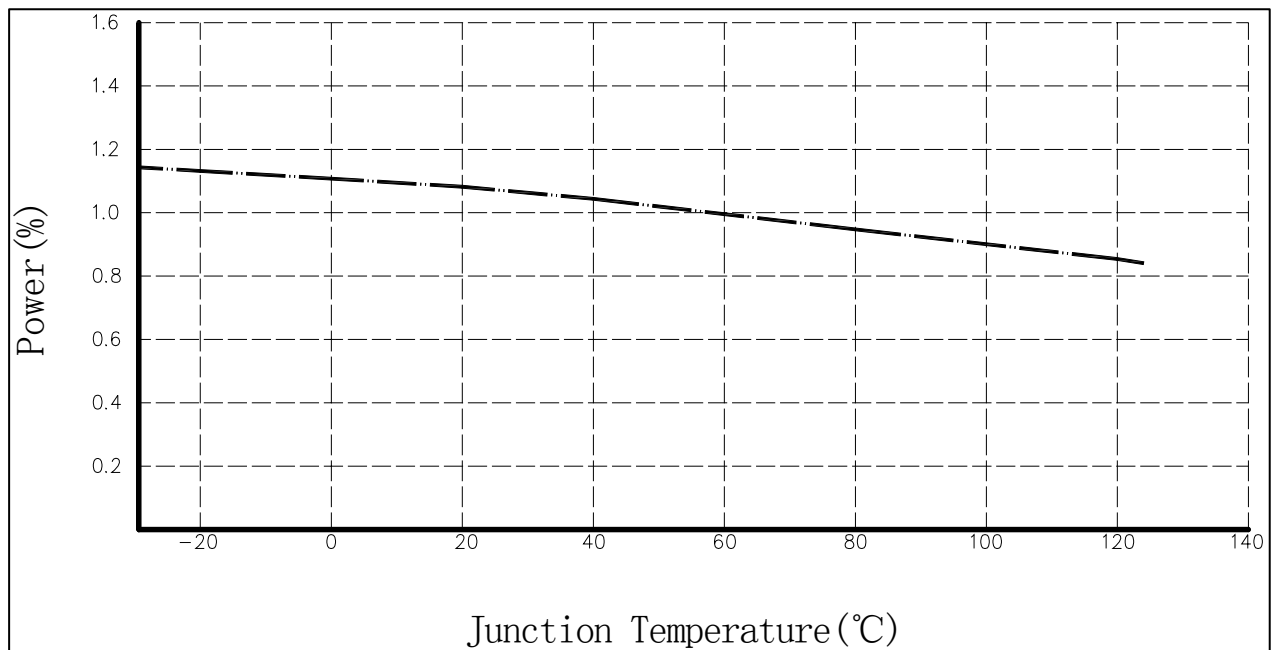
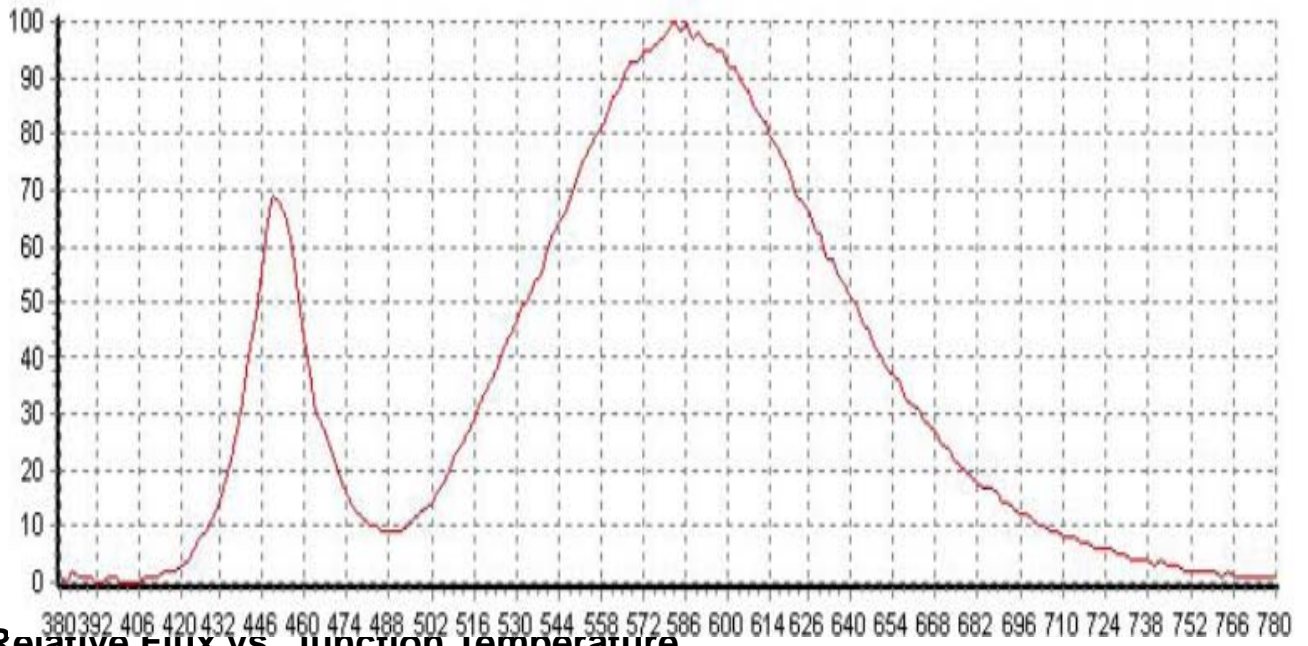

## Thermal Design

The maximum forward current is determined by the thermal resistance between the LED junction and ambient. It is crucial for the end product to be designed in a manner that minimizes the thermal resistance from the Lume COB LED case to ambient in order to optimize lamp life and optical characteristics.

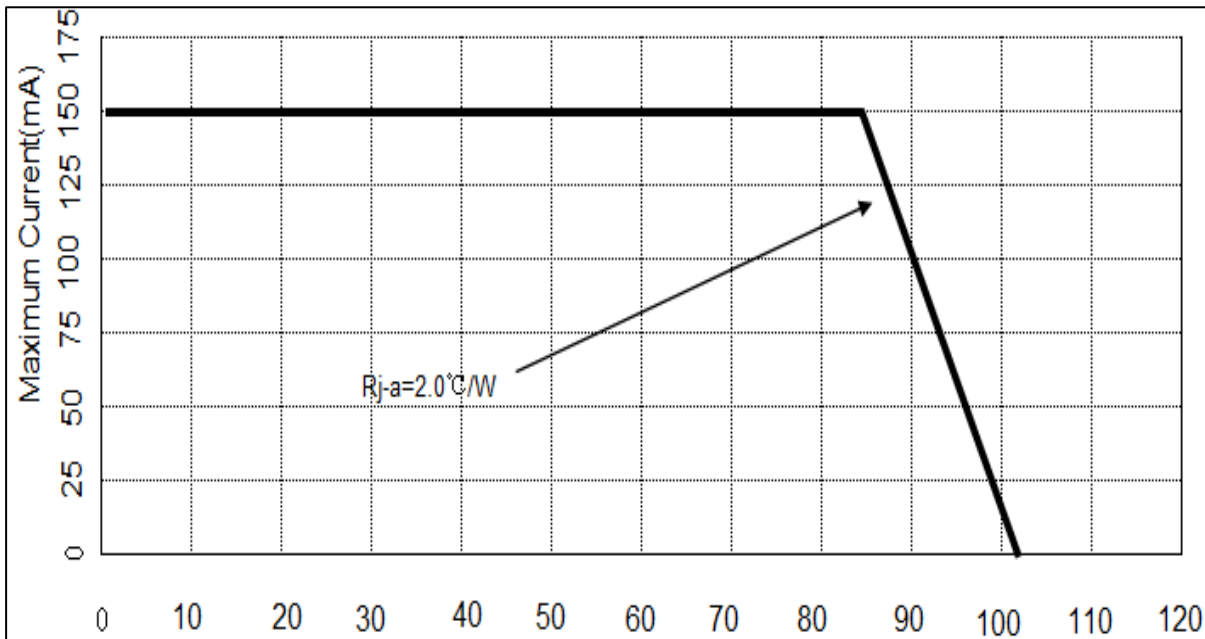

Maximum Forward Current vs. Ambient Temperature for LC35-050W-W

## Typical Polar Radiation Pattern

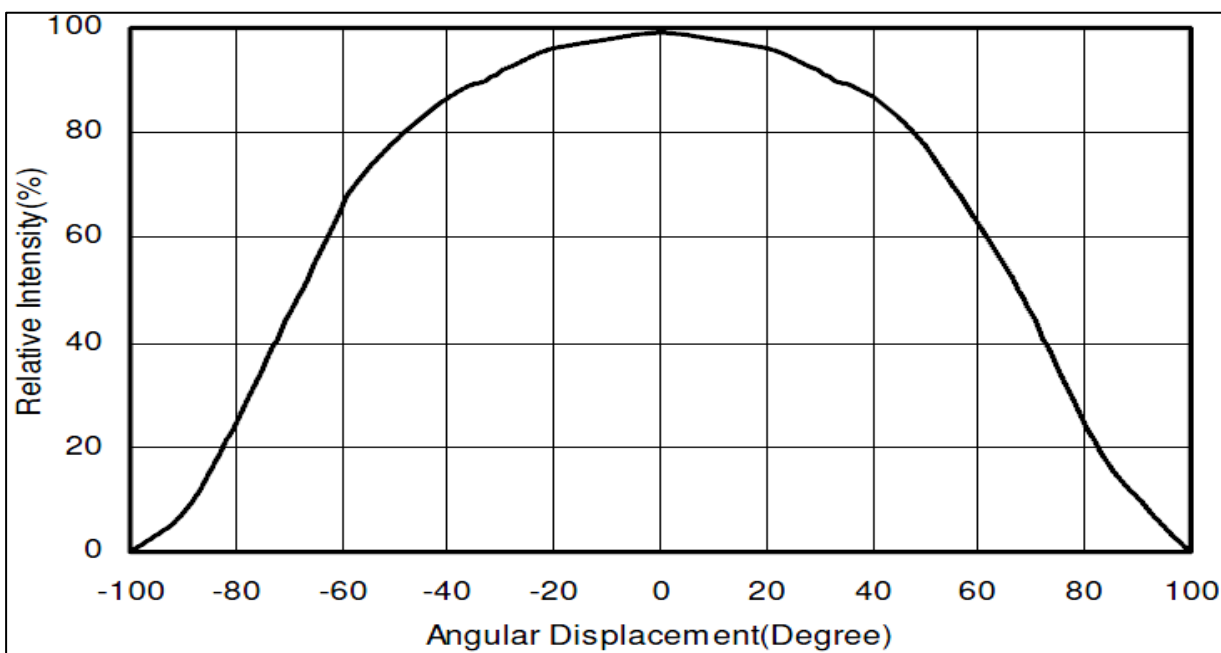

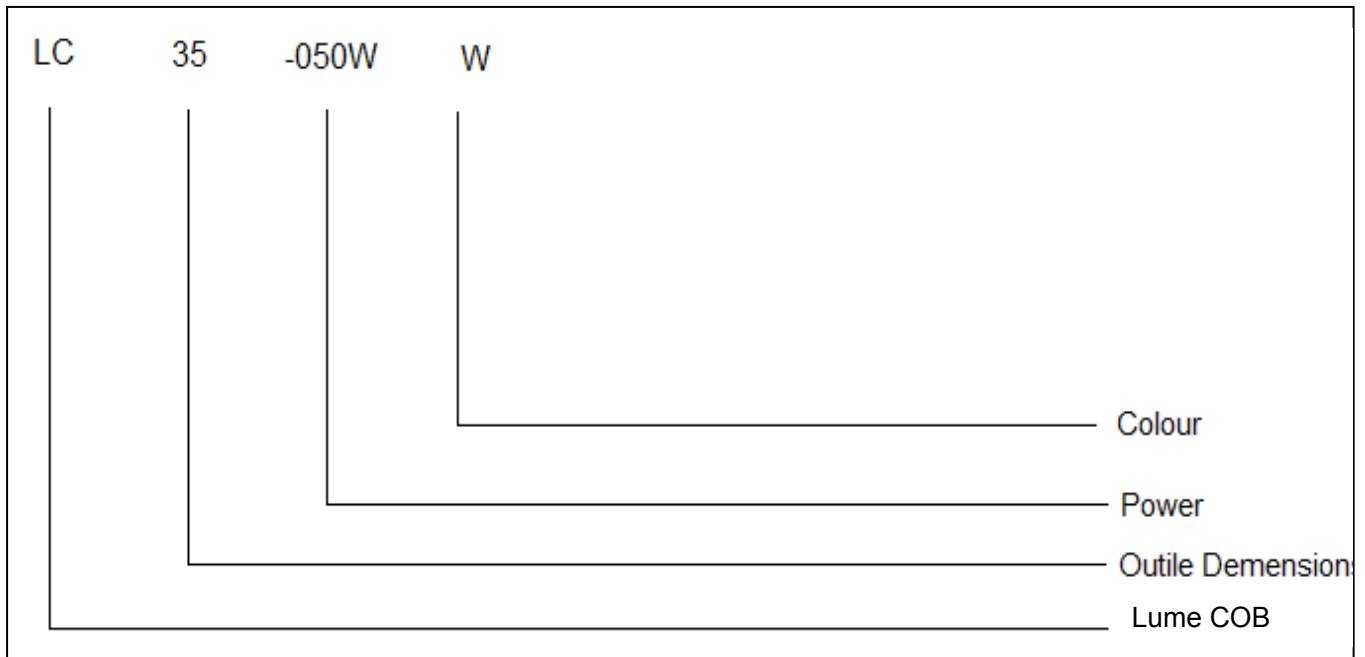

## Order Code

Colour / White	
R	Red
G	Green
B	Blue
A	Amber
O	Red-Orange
V	violet
M	RGB
C	Cool white
N	Neutral white
W	Warm White

More detail please see “[Lume COB LED Binning and Labeling.pdf](#)”

### NOTICE:

- All dimensions are in millimeter.
- Tolerance is  $\pm 0.1$ mm unless otherwise noted.
- It is strongly recommended that the temperature of lead be not higher than 60°C.
- This information in this document is subject to change in order to improve reliability, design or

function without prior notice and does not represent a commitment on the part of this company.